

Battery Electrical System Analyser (12-2415)



Introduction

12-2415 is our latest version of Battery Analyser which test 12V systems (4 functions) and 24V systems on Starters and Alternators (Normal and Smart). This tester revolutionized its display format and is the first in the world with fully graphical display. The graphical display is simple; with step by step instructions enable the user to clearly understand the operation. The symbols used are universal which solve language barrier.

The unit comes with an integrated printer so the graphical results can be printed immediately after each test. Its memory stores up to 70 previous test results for later viewing. With its PC Link feature, allows the results to be transferred and stored in the computer via an USB cable and PC Link software installed into the computer beforehand.

The Battery Analyser operates on all 12V or 24V Batteries and is able to perform four tests namely:

1. Battery Test:

This Test is intended only on 12V batteries. The analyser clips (red & black) have to be clamped onto the battery terminals. When the analyser detects the voltage present, the analyser will automatically remind the user that it can test only on 12V battery when connected to the 24V system.

- Analyses the battery condition using microprocessor controlled testing methods without the need of fully charging it before test.
- The unit consumes very little current during testing hence the test can be repeated numerous times without any worry of draining the battery and its results are highly accurate.
- Extremely safe as it does not create any sparks during clamping and it takes less than 8 seconds to obtain the full analysed results of tested battery.
- Temperature compensated end Results.
- It is powered up from the testing 12V or 24V battery. No maintenance is required during its lifetime service.

2. Grounding Test:

Same as battery test, this test is also meant for 12V batteries only.

- Analyses the condition of the electrical return circuit contacts resistance which were connected to the engine or chassis body from the battery terminal with results and recommendations display after test.

3. Starter Test:

This Test can be performed on 12V and 24V Starters.

- Checks the cranking effectiveness of the battery to predict when the battery will fail to crank a vehicle basing on voltage profiles with results and recommendations display.

4. Alternator Tests (with diode ripple test):

This test can be done on 12V and 24V Alternators (Normal or Smart).

- These tests check the alternator charging conditions during load at 1,500 ~ 2,000 RPM, without load at 2,500 ~ 3,000 RPM and the diodes ripple volts with results and recommendations display after each test. This test will determine whether the alternator is performing its job properly.

Specifications:

Operating Voltage: 9V ~ 36V DC (max)

Test Functions

12 Volts:	Battery test, Starter test, Alternator + Diode ripple & Grounding tests
24 Volts:	Starter test, Alternator test (Smart and Normal alternator)

Analyzing Capacity (Amps):

Automotive 12V Batteries:	CCA/SAE: 100A ~ 2000A	EN1: 100A ~ 2000A
	CA/MCA: 100A ~ 2000A	EN2: 100A ~ 2000A
	IEC: 100A ~ 2000A	DIN: 100A ~ 2000A
	JIS#: 100A ~ 2000A	

Motorcycle 12V Batteries:	CCA/SAE: 40A ~ 600A	EN1: 40A ~ 600A
	CA/MCA: 40A ~ 600A	EN2: 40A ~ 600A
	IEC: 40A ~ 600A	DIN: 40A ~ 600A
	JIS#: 40A ~ 600A	

DC Volts Accuracy: ± 1% Reading

Battery analysing time: Less than 8 seconds.

Maximum key-in: 17 characters

Safety: Reverse polarity protected. Analyser will not power ON.

Internal Memory storage: Store up to 70 Test Results.

PC communication: Through USB port.

Printer: Built-in

Printer head: Thermo unit.

Paper width: 57.5mm ±0.5mm

Paper roll diameter: Max. 45mmO.D

Printing Speed: 50mm/sec

Working Temperature: 0°C (32°F) ~ 50°C (122°F)

Working Humidity: 10% ~ 80 %

Approvals: CE, ROHS

Safety precautions:

- When the engine is running, it produces carbon monoxide, a toxic and poisonous gas. Always operate the vehicle in a well-ventilated area. Do not breathe exhaust gases – they are hazardous that can lead to death.
- To protect your eyes from propellant object such as caustic liquids, always wear safety eye protection.
- Fuel and battery vapors are highly flammable. **DO NOT SMOKE NEAR THE VEHICLE DURING TESTING.**
- When engine is running, many parts (such as pulleys, coolant fan, belts, etc) turn at high speed. To avoid serious injury, always be alert and keep a safe distance from these parts.
- Before starting the engine for testing or trouble shooting, always make sure the parking brakes is firmly engaged. Put the transmission in Park (automatic transmission) and Neutral (manual transmission).
- Always block the drive wheels. Never leave vehicle unattended while testing.
- Never lay tools on vehicle battery. You may short the terminals together causing harm to yourself, the tools or the battery.
- Do not wear loose clothing or jewelry while working on engine. Loose clothing can get caught in fan, pulleys, belts, etc. Jewelry can conduct current and can cause severe burns if comes in contact between power source and ground.
- Always keep a fire extinguisher readily available and easily accessible in the workshop.

Working with Batteries:

Lead-acid batteries contain a sulfuric acid electrolyte, which is a highly corrosive poison and will produce gasses when recharged and explode if ignited. It can hurt people badly.

When working with batteries, make sure you have plenty of ventilation, remove your hand jewelry, watch and wear protective eyewear (safety glasses), clothing, and exercise caution.

Do not allow battery electrolyte to mix with salt water. Even small quantities of this combination will produce chlorine gas that can KILL you!

Whenever possible, please follow the manufacturer's instructions for testing, jumping, installing, charging and equalizing batteries.



- Never disconnect a battery cable from a vehicle with the engine running because the battery acts like a filter for the electrical system.

Unfiltered [pulsating DC] electricity can damage expensive electronic components, e.g., emissions computer, radio, charging system, etc.

Turn off all electrical switches and components; turn off the ignition before disconnecting the battery.

- For non-sealed batteries, check the electrolyte level. Make sure it is covering the plates and it is not frozen before starting to recharge (especially during winters).
- Do not add distilled water if the electrolyte is covering the top of the plates because during the recharging process, it will get warm and expand. After recharging has been completed, recheck the level.
- Do NOT smoke or cause sparks or flames while the battery is being recharged because batteries give off explosive gasses.

Preparing for Test:

1. The Battery Analyser operating voltage is from 9V to 36V DC. For Battery and Grounding tests on 24V system (12V x 2 batteries connected in series), disconnect the connection between each battery and clamp the analyser clips to one battery at a time and test them individually. For Starter Test (Cranking) and Alternator Test (Charging), these tests can be done on 12V or 24V system.
2. Battery that has just been charged by the charger contains surface charge and it should be discharged by turning ON the Head lights for 3~5 minutes before testing.
3. Always attached the tester clips on the lead side of the battery terminal posts during testing so that it has a good contact. This will provide better and accurate results.
4. Do not attach the tester clips directly onto the steel bolt that tightened to the battery terminal posts; this may give inaccurate readings or inconsistent results. (Note: This also applies to all other battery testing methods.)
5. During testing on the battery whilst it is still in the car, make sure the engine, all accessories and load are OFF. Close the trunk lid and all doors.
6. Inspect the battery for cracks or broken casing. Do not use the Tester if the battery is damaged.
7. If the battery is a WET type: non sealed maintenance free, top up the level as specified by the markings on the battery with distilled water. This will help to purge the gas from the cells. DO NOT OVERFILL.
8. If necessary to remove the battery from the vehicle to test, ALWAYS remove the negative terminal from the battery first. Make sure all accessories are OFF so that you do not cause any arcing.

Initial Setup

Printer paper installation:

Open the printer cover by pushing it upwards from the middle. Place the roll of thermal paper into the slot with the paper edge facing up (Fig. 1). Make sure the paper is about 1.0 inch (25.4 mm) out when the printer cover is closed (Fig. 2).



Fig.1

Fig.2

Setting of Date and Time:



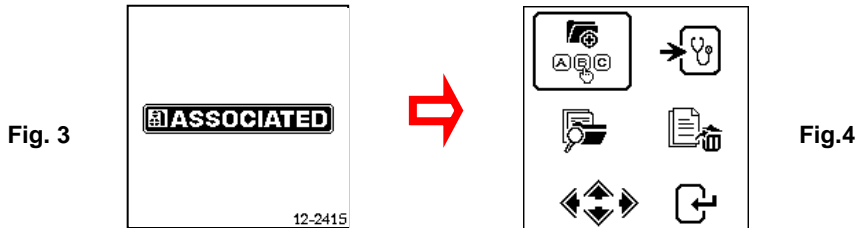

The date and time on the Analyser were set in the factory during production. Due to the differences of the Time zone in your Country, you may need to set according to your local date & time and this can be done by doing the following steps:

1. Power up the Analyser by hooking up to a 12V battery, the screen will light up and the display will show as follows:

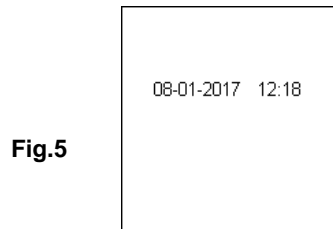



2. While still in this display (Fig.4), press the  and hold for about 3 seconds, there is a long beep sound which indicates Date and Time setting adjustment. The display will change and show as in Fig.5 below.









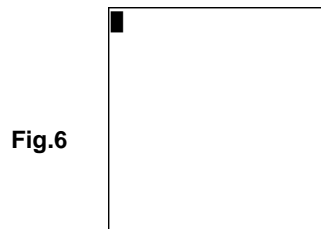



3. Use  key to move backward or  key to move forward,  key to increase the number and  key to decrease it. When completed, press  key will return to the main menu (Fig.4).

Key in Company name and contacts

This feature is for the user to key-in the company or garage name and the contact information to be printed into the test report header. It allows 20 characters in one line and accommodates up to seven lines maximum. To enter into this mode, power ON the analyser by clamping into the battery terminals then after the beep press  key twice (2 times) then press  key. It will enter into the display as shown below (Fig.6).



1. Using the keys  or  to scroll the numbers (0 to 9) or characters (A to Z) to input.
2. To move one space backward of forward, use  or  keys. Also if there is a need to correct any character or number that was previously keyed-in, use these keys to move backwards and correct the entry using  or  keys.

3. Once confirmed, press  key will move to the next line below.
4. To clear at once all the characters being key in, press  key.
5. When the key in had finished, press  key to save the entry and then press  key to exit.

Note:

The information that has been keyed in will be shown in the result printout after test (see Fig.87).

Switch ON / OFF Key Sound beep

Whenever a key is press, there is a corresponding beep sound which can be heard as to indicate that a key has been pressed. This sound can be switched ON or OFF by doing the following:

1. Go to the Main Menu as shown in Fig.4 above.
2. Press and hold  key for about 3 seconds and a long beep sound will be heard which indicates that the change has taken place.
3. Then press any key and the sound is OFF.
4. To reverse back, do the same procedure as mentioned in step 2 and the sound will be switched On.

Car / Truck Battery Test:

This test is intended for **12V Batteries** but not on 24V. The reason is most trucks that use 24V systems have two 12V batteries connected in series to produce 24V. To test on 24V system (12V Battery x 2), disconnects the connection between each battery and test one battery at a time.

The test results of individual battery is more accurate than testing two batteries at once due to the unwanted resistance created by the cable joining of the first battery to the second battery that make 24V. So the battery test is catered for all 12V Batteries only.

Performing Battery Test whilst it is still in the car or truck:

Vehicle that was running has to have its engine OFF first and then switch ON the headlights for 30 seconds to remove the surface charge. After the headlights had switched OFF, let the battery rest for at least 1 minute to recover before testing commences.

The car or truck engine and all other accessory loads must be **OFF** during test in order to have accurate results. When attaching the analyser clips, make sure that the battery posts were not oxidized or badly corroded. Clean them first before clamping to it. Do not clamp onto the steel bolts directly which may give inaccurate and inconsistent results.

If the red and black clips were accidentally clamped directly on to the 24V output terminals of the battery while testing truck batteries, the Analyser display will show (Fig.7 and Fig.8) as below:

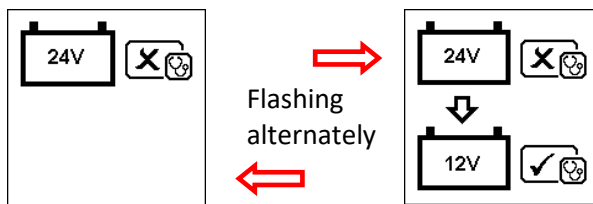
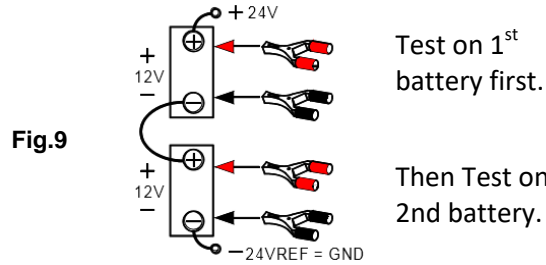

Fig.7

Fig.8

This is to indicate that it cannot test on 24V battery. In this case, if the truck consists of two 12V batteries then test them individually (one at a time) Fig. 9 below.



Testing on stand-alone Batteries:

Clean the battery posts with a wire brush prior testing. For side post batteries, install stud adaptors. Do not use steel bolts for better results.

1. Clamp the Analyser black clip to the battery negative terminal (-) and red clip to the battery positive terminal (+). The Analyser LCD will light up with the wakeup screen (Fig.10).

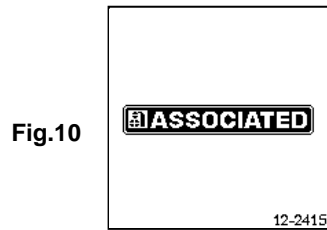

2. When one of the Analyser clamps is not properly secured to the battery posts, it will prompt you as shown below (Fig. 11 and 12 flashing alternately). In this case, unclamp and clamp the Analyser clips again on the battery posts. Here the Analyser will ensure that its contacts are good before conducting a test.



3. If the contacts between the battery and the Analyser have no problem, then the Menu screen will display as shown below (Fig.13):

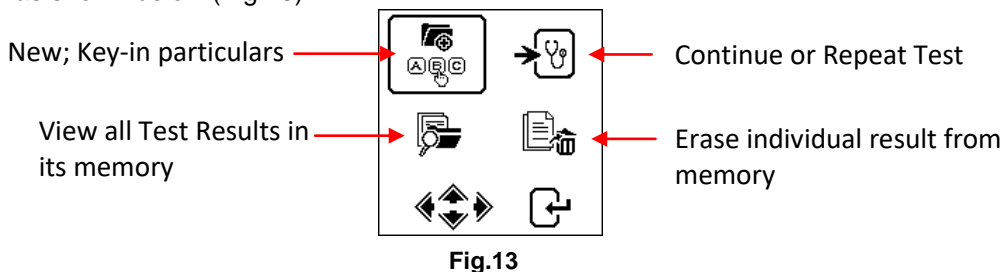



Here, it will let you select your choice from the Menu:

New: Key-in Particulars:

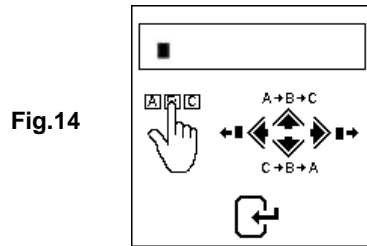

The Analyser will always begin in this mode. Once entered, the display will show (Fig.14) as below:



To key-in the particulars (e.g. VIN, vehicle registration numbers/ battery model/ testing date/ customer's name/reference numbers/ etc. which can only be entered with a single choice having not more than 17 characters), press ▲ key to scroll up the alphabet A,B,C ~Z and numbers 1,2,3~0 while ▼ key to scroll down from Z,Y,X~A or 0,9,8~1 to select. Press▶ key will move one space to the right while ◀ key will move one space backwards for editing purposes. Then press  key to confirm.

Note: If you do not input any particulars and straight away press  key to continue, then the test results will not save in its memory.

To Continue or Repeat Test:



Selecting this function allows user to continue or repeat the last test and no need to key-in (type) the particulars again on the same car from where the last test was conducted and it will update the results.

For example:

If you had done Battery Test and later wish to perform Alternator Test or Grounding Test on the same car, just select this function and it will update the results after each test in its memory and it can be retrieved for review later or to be printed out.

View Test Results from the memory:



This lets the user view all the test results stored in its memory. Once entered, the display will show (Fig.15) as below showing all the particulars that was key-in (type) during the test. Press ▲ key to scroll upwards and ▼ key to scroll downwards to select. During scrolling the bar highlight will move up or down on the required particulars.



Press ◀ or ▶ key to move forward or backward to the next page. Once confirmed, press ↩ to view the results:

Examples:

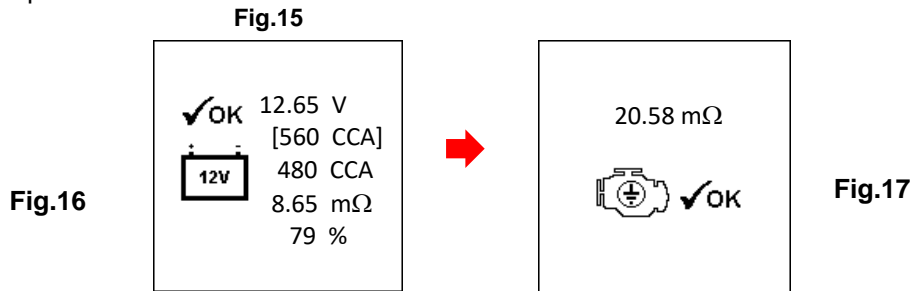

Delete individual result from the memory:



When this function is selected, it lets the user select and delete the result individually from the memory. Once entered, the display will show (Fig.18) as below which shows all the particulars that was key-in (type) during the test.

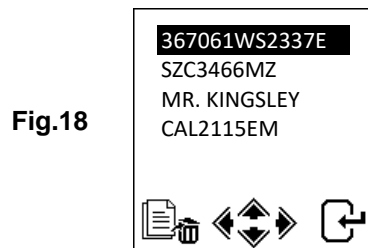



Press ▲ key to scroll upwards and ▼ key to scroll downwards to select. During scrolling the bar highlight will move up or down on the required particulars.

Press ▶ key to move forward or ◀ key to move backward to the next page. Once confirmed, press ↩ key. Then press again ↩ key one more time will delete the result. This action allows user to double confirm before deleting the result.

Continue from Step 3 above:

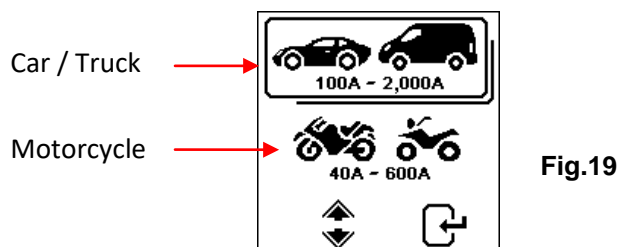
4. After you have made your choice, you can begin testing by selecting or will proceed to the display below: (Fig.19)



Selecting  will allow you to test car Batteries (up to 2000A) whereas  will only test Motorcycle Batteries (up to 600A) only.

Here if you have selected  test, then there is an option to select Battery or other system test. See display below (Fig.20).

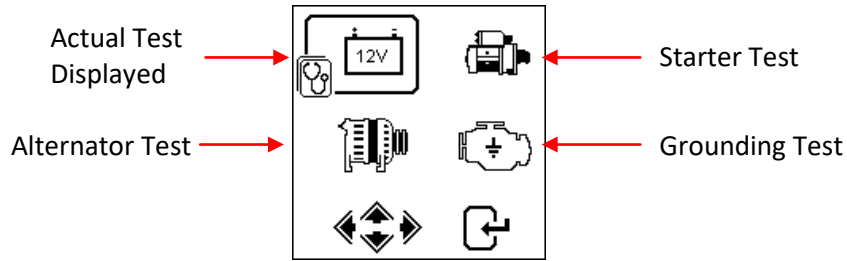
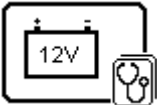



Fig. 20

Select for Battery test  and then press  key.

5. If the tester detected that the battery has surface charge it will prompt you to turn the ignition key to ON and switch on the headlights (Fig.21) to discharge the battery until it has reached to the next display that shows turn ignition OFF and headlights OFF (Fig.22) as display shown below and then press  to continue.

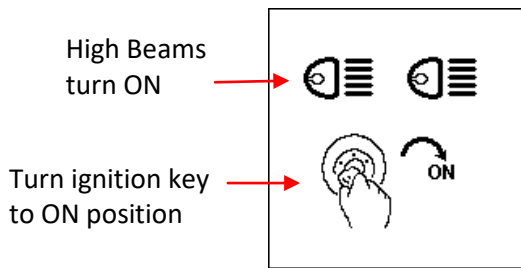

Fig.21

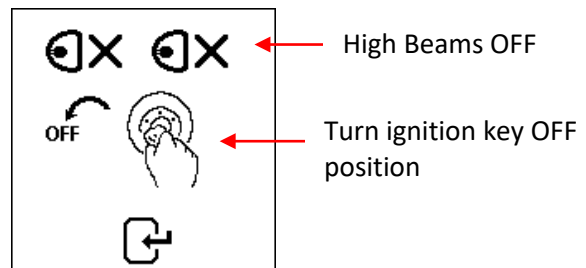

Fig.22

6. Next it will prompt you to select the types of batteries (Fig.23) :

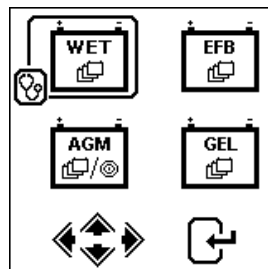

Fig. 23

WET (SLI) battery is meant for all normal flooded types like Wet Low Maintenance (Lead [Pb] / Calcium [Ca]) or Wet Standard (Lead [Pb] / Lead [Pb]) Batteries.

AGM FLAT / SPIRAL tests on Wet (MF) Maintenance Free (Calcium [Ca] / Calcium [Ca]), AGM flat or spiral plates Batteries.

EFB tests Start/Stop or Enhanced Flooded Batteries.

GEL tests Gel Cell VRLA Batteries with units of measurement in Cold Cranking Amps.

- Before selecting the ratings 'CCA, SAE, EN, IEC, DIN, CA and JIS #' from the menu, check the battery specification value. This value can be checked on the battery labels as some of the examples shown below:



- Once the selection has been done, it will proceed to the display as shown below (Fig.24):

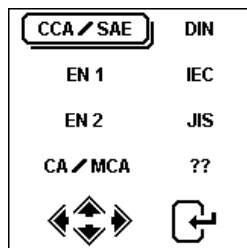

Fig.24

- If the rating is selected under JIS # (Japanese Industrial Standard) then you need to refer to the conversion chart provided separately with the Tester when purchased to convert to CCA ratings.

Refer to the battery model (example: 80D26L or NX110-5L) on the Cold Cranking Amps (CCA), WET is 580 CCA and AGM is 630 CCA.

Battery Model (JIS#)		CCA			Battery Model (JIS#)		CCA		
NEW	OLD	WET	MF	CMF SMF	NEW	OLD	WET	MF	CMF SMF
50D20R		310	380	480	80D26L	NX110-5L	580	580	630
50D20L		310	380	480	85B60K				500
50D23R	85BR60K	500			85BR60K				500
50D23L	85B60K	500			95D31R	NX120-7	620	660	850
50D24R	NT80-S6	390			95D31L	NX120-7L	620	660	850
50B24L	NT80-S6L	390			95E41R	N100	515	640	770
50D26R	50D20R		370		95E41L	N100L	515	640	770

- You can also use the rough CCA guide below, basing on the engine capacity of vehicle but the percentage (%) Life is not that precise as compare to the actual battery rating due to this rough estimation.

1000 – 1299 cc	300 CCA
1300 – 1599 cc	400 CCA
1600 – 1999 cc	500 CCA
2000 – 2999 cc	700 CCA
3000 – 3500 cc	800 CCA

- To enter the value, press ◀ or ▶ key will increase or decrease the original value shown on the display by 100 units. Likewise use ▲ or ▼ key to increase or decrease the last two digits step of 5 units for each press. See Fig.25 below.

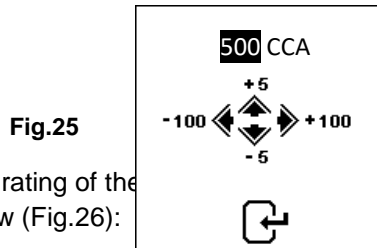

- Once the Amps rating of the battery is set, press the square key will start the testing process. Refer to the display below (Fig.26):

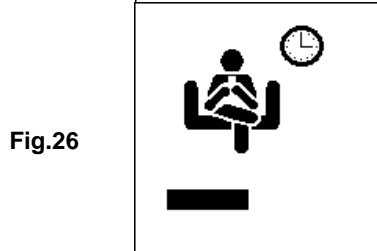

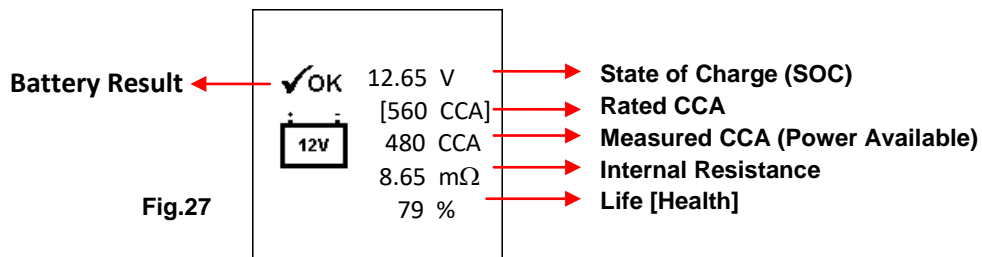

- For less than 8 seconds, the results of the testing will be displayed on the LCD screen (Fig.27) if the battery condition is very good (e.g. having more than 75% Life).



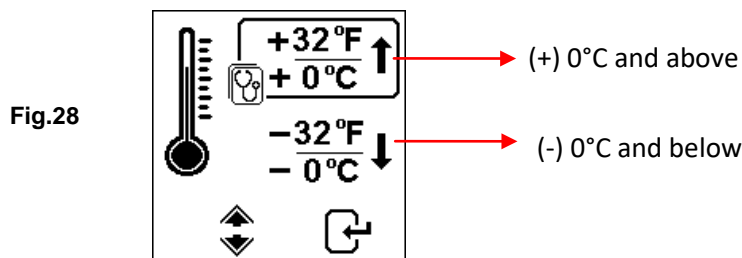

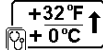
- This Analyser will also take the temperature of the battery into consideration when it has detected that the battery condition is marginal (SOC below 75%) and it will prompt you with the display as shown (Fig. 28) below:

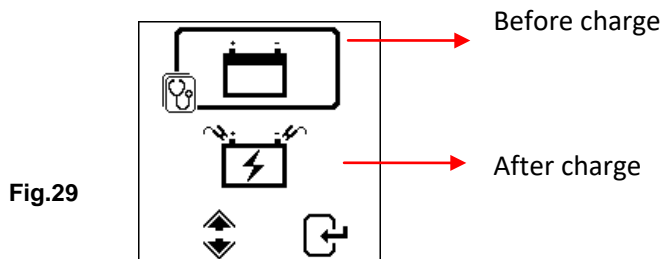

Here it let you to select the surrounding temperature that you are working with the battery. If the surrounding temperature is for example 15°C, then select  and press  key. Then the results will show on the LCD display (Fig.27).

- Sometimes the analyser will prompt and ask whether the battery has been charged or before charge (Fig. 29) during the testing. Selecting “Before charge” or “After charge” will determine its final test results.



16. To print out the results, just press  key on the Analyser, the printer will start printing.

Motorcycle Battery Test:

To test motorcycle batteries, it is better to test with the battery taken out from the motorcycle for better results. This is mainly due to the obstruction of the wires that were attached to the battery terminals and the tester clamps may not clip properly due to lack of space at its terminals thereby may cause false test results.

17. While on the main menu as shown (Fig.30) below, select  for Motorcycle Battery test.

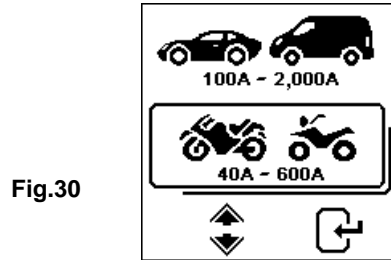



Fig.30

18. Press  key, the screen will show as (Fig.31) below:

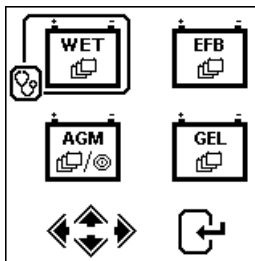

Fig.31

19. For Motorcycle Batteries before selecting whether [WET (SLI)] or [AGM] and the ratings 'CCA, SAE, EN, IEC, DIN, CA and JIS #' from the menu, check the battery model. This can be checked on the battery labels as some of the examples shown below:



With the battery model in hand, refer to the Battery rating chart (as seen in this example Fig.32 below) provided in separate copies with the Tester when purchased, to get values to be keyed in.

Battery Model	AH	CCA		Battery Model	AH	CCA	
		WET	AGM			WET	AGM
YT4L-4	3		50	YTZ12S-BS	11		210
YT7B-4	6.5		110	YTZ14S	11.2		230
YT7B-BS	6.5		110	YTZ14S-BS	11.2		230
YT9B-4	8		120				

Fig.32

Once the battery type [SLI (WET)] or [AGM] has been selected, it will proceed to the display as shown below (Fig.33):

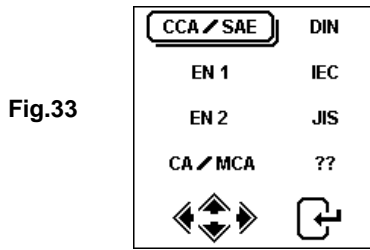

20. Press key and the display will show as in (Fig.34). To enter the value, press or key will increase or decrease the original value shown on the display by 100 units.

Likewise use or key to increase or decrease the last two digits step of 5 units for each pressing.

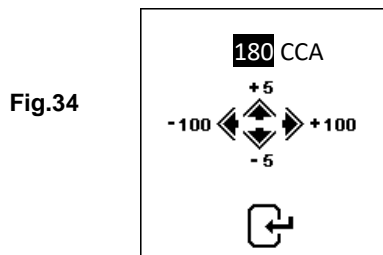

21. Once the Amps rating of the battery is confirmed, press key will start the testing process. Refer to the display below (Fig.35):

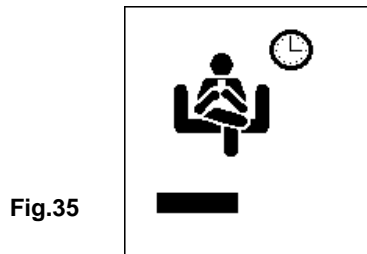

22. For less than 8 seconds, the results of the testing will be displayed on the LCD screen (Fig.36)

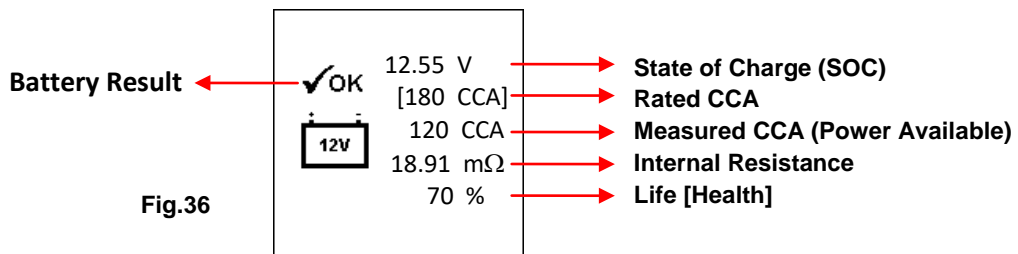

23. To print out the results, just press key on the Analyser, the printer will start printing.

Interpretation of Results:

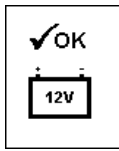

The battery is in good condition.

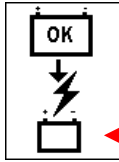

The battery is OK but need to recharge first in order to have the maximum performance.

Flashing

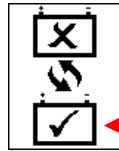

The battery is weak, need to be replaced with a good one.

Flashing

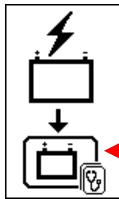

The battery need to recharge first and then test again to confirm the final results.

Flashing

2. Volts : 12.55V (State of Charge [SOC])

The volts here indicated the State of Charge (SOC) of the tested battery which is 12.55V during open circuit condition. [By referring to the table below, this battery is above 50% SOC]

- State Of Charge(SOC)	WET/SLI	AGM	GEL
100 %	12.60 V	12.80 V	12.85 V
90 %	12.58 V	12.72 V	12.77 V
80 %	12.44 V	12.64 V	12.69 V
75 %	12.40 V	12.60 V	12.65 V
50 %	12.20 V	12.30 V	12.35 V
25%	12.00 V	12.00 V	12.00 V
0%	11.80 V	11.80 V	11.80 V

3. Battery Rating: 180 CCA

The battery capacity rated output is normally stated on the label for car batteries (either in CCA, EN, DIN, JIS, etc.). For batteries with model numbers, please refer the charts provided with the Analyser.

4. Power available: 120 CCA

It means that the battery tested has a capacity of 120 CCA power available. CCA ratings has been used here, therefore the tested result is in CCA and if other rating (DIN, SAE, JIS, IEC, CA, or EN) were selected, it will base on the respective rating to calculate and show the results in that selected rating.

Please take Note:

This output value (120 CCA) is related to the actual power available in the battery in relation to that battery's rating (180 CCA). On average, a new battery's CCA as measured by this tester will read 10-15 % higher than its stated rating.

As the battery ages, the CCA number measured by this tester will decrease so it reads near its rating. While this value is not the same as a CCA test, it is the best available measurement for showing a battery's current condition in relation to its rating.

From the above example, a 180 CCA rated battery measuring 120 CCA available power does not mean that the battery would pass a CCA test at 120 CCA.

The available power reading shows that the battery is not able to perform up to its rated ability (180 CCA).

In comparison to another battery when fully charged, the 180 CCA battery measuring 120 CCA is no stronger than a 100 CCA battery showing 100 CCA available power when fully charged.

The available power number is meant for comparison to its own rating. In fact, in this example the 180 CCA battery was failing to perform to its rating, while the 100 CCA battery is still working.

Basing on the Society of Automotive Engineers (SAE) in America, CCA test is a manufacturing process control test applicable only on new, fully charged batteries. It does not produce an actual value, but is a PASS / FAIL test.

It measures the discharge load, in amps, that a battery can supply for 30 seconds at 0°F/-18°C while maintaining a voltage of 1.2 volts per cell (7.2 volts per battery) or higher.

Thus, the CCA test shows the minimum power requirement for the battery as rated, which means a battery rated at 400 CCA must measure 7.2 volts or above for 30 seconds when a load of 400 amps is applied at 0°F/ -18°C.

5. Internal Resistance: 18.91mΩ

In normal condition, the internal resistance of the motorcycle battery should fall in the range of between **5.0 mΩ ~ 45.0 mΩ** is considered to be good. Anything above 45.0 mΩ resistance shows that its internal plates has been aged or sulfated.

For car batteries, its internal resistance of **2.0 mΩ ~ 15.0 mΩ** is considered to be good due to high CCA value they have.

As a matter of fact, the higher the battery CCA readings obtained the lower the internal resistance should be.

6. LIFE: 75 %(Health)

This is an indication of the battery life expectancy [Health] in percentage.

Explanation of the following terms used as shown on the LCD display:

- **CCA (Cold Cranking Amps) – most commonly used Standard.**

CCA is a rating used in the battery industry to rate a battery's ability to start an engine in cold temperatures. This rating is the number of amperes that a new fully charged battery can delivery at 0°F (-18°C) for 30 seconds, while maintaining a voltage of at least 7.2 Volts for a 12V battery during cranking.

- **SAE (The Society of Automotive Engineers) Standard.**
SAE has established Cold Cranking Amperes (CCA) rating for batteries as their standard. Therefore this rating is the same as CCA rating as mentioned above.
- **IEC (International Electro technical Commission) Standard.**
IEC amperes rating require that at 0°F (-18°C), the number of amperes that the 12V battery can deliver while maintaining a voltage of at least of 8.4 Volts for 60 seconds during cranking.
- **EN 1 (European Norms) Standard.**
EN 1 amperes rating require that at 0°F (-18°C), the number of amperes that the 12V battery can deliver while maintaining a voltage of at least 7.5 Volts for 10 seconds discharged at the rated current, followed by 10 seconds rest, then it is discharged at 60% of the original current for further 73 seconds to give an equivalent total discharge time at the lower current of 90 seconds still maintaining 7.5 Volts.
- **EN 2 (European Norms) Standard.**
EN 2 amperes rating require that at 0°F (-18°C), the number of amperes that the 12V battery can deliver while maintaining a voltage of at least 7.5 Volts for 10 seconds discharged at the rated current, followed by 10 seconds rest, then it is discharged at 60% of the original current for further 133 seconds to give an equivalent total discharge time at the lower current of 150 seconds still maintaining 6.0 Volts.
- **JIS# (Japanese Industrial Standard)**
JIS # amperes' rating is based on Ampere Hours and is calculated using 20 hours rating. In this manual, it is using CCA ratings reference table list provided basing on the JIS model number.
- **DIN (Deutsches Industrie Normen)Standard.**
Basing on DIN , the rating requires that at 0°F (-18°C), the 12V battery is able to deliver the number of amperes while maintaining a voltage of at least of 9.0 Volts for 30 seconds and 8.0 Volts for 150 seconds during cranking.
- **CA (Cranking Amperes) / MCA (Marine Cranking Amperes) Rating.**
This rating is the number of amperes that a new fully charged battery can delivery at 32°F (0°C) for 30 seconds, while maintaining a voltage of at least 7.2 Volts for a 12V battery during cranking.
- **?? (Unknown)**
If you are not sure which ratings (CCA, EN, IEC, JIS or DIN) that the battery is based on, then choose this setting. It will show the battery's Voltage (State of Charge), CCA and the Internal Resistance (mΩ) only.

This selection can also be used to test 12V - Deep Cycle Batteries. An example of the results display is shown below: (Fig.37)

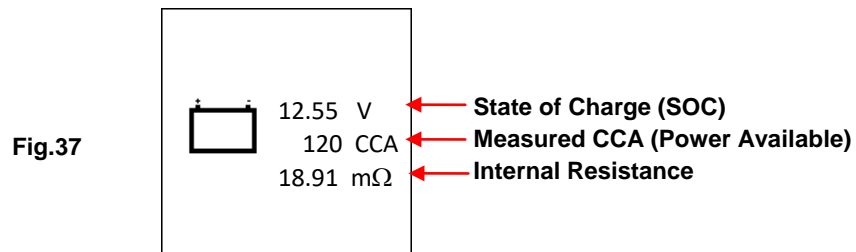

To determine the condition of the tested Deep Cycle Batteries, refer the **Volts** reading – State of Charge (should not fall below 12.60V when fully charged for Lead Acid Batteries, 12.85V for Gel Batteries and 12.80V for AGM Batteries) and the Internal Resistance [**Int. R**] of the tested battery should not be more 15 mΩ readings can be considered to be a good battery.

- 7. Batteries that had been left idle for long periods can still be tested with this analyser. To perform the test, just clamp the analyser clips onto the battery terminals and it will display the screen (Fig.38) as shown if its voltage falls below the normal 12.0 volts.

Note: Any battery whose voltage falls below 10.6V will be considered a shorted battery.

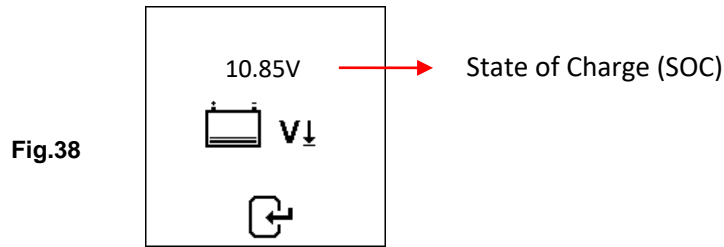

Press key to continue and the display will show: (Fig.39)

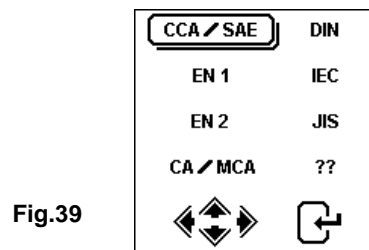

Check the battery ratings and enter it as described earlier and the results will show as an example below: (Fig. 40 and Fig.41)

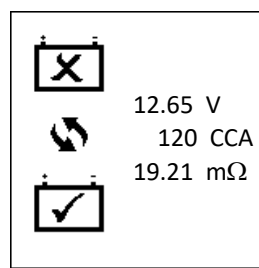
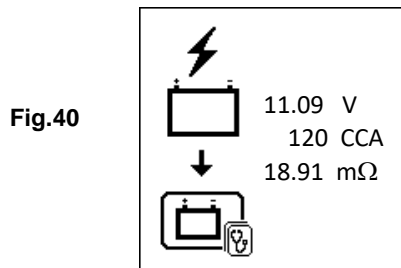

Fig.40 - Results shown [Recharge and test again], it indicated that the battery has to be fully charged first before repeating the test. Reason: State of Charge: 11.09V is too low.

For Fig.41 - Results shown [To replace], this meant that the battery need to be replaced as its internal plate resistance [Int. R] 19.21mΩ is higher than 15 mΩ limit.

Pressing the key at any moment will exit and return back to the main menu display.

Starter Test:

This test is only available in test and it actually checks the cranking effectiveness of the 12V or 24V battery system during starting and also the starter condition.

- 1. With engine OFF, place the vehicle transmission in NEUTRAL for Manual and PARK for Automatic then apply the hand brake.

2. Connect the tester to the battery terminals and the displays will light up as shown below.

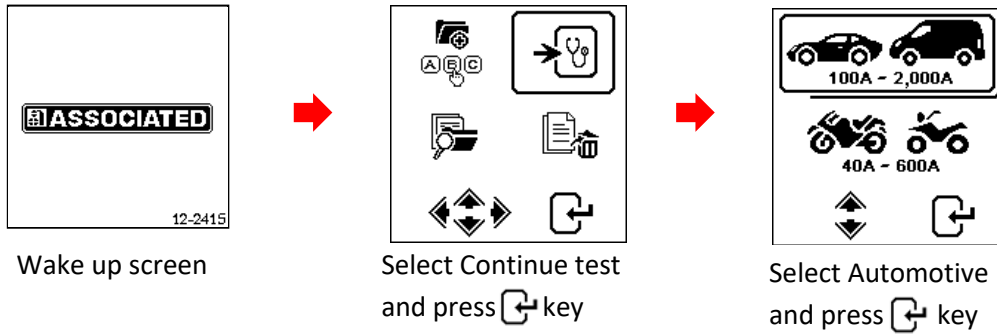

From the main MENU (Fig.42), select  by scrolling left using  key

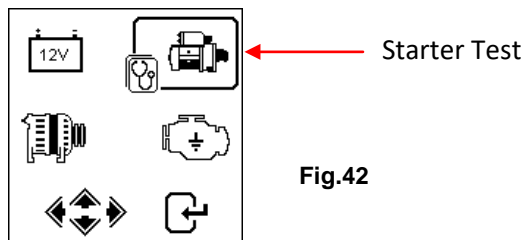



Fig.42

Press  key to continue and the display will show:

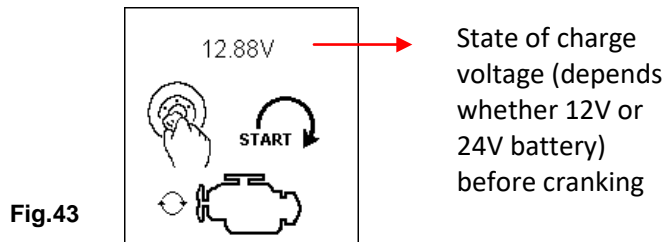

Fig.43

Note: In event that you did not crank the engine while on this screen; the starter test will be terminated after 30 seconds and return to the main menu.

3. Now switch the ignition key to ON and start cranking the engine until it starts. As soon as the engine starts, the results will automatically display as shown in examples below :(Fig.44 or Fig. 45)

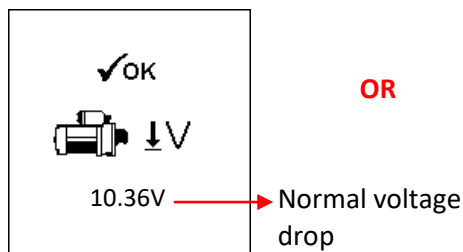

Fig. 44

OR

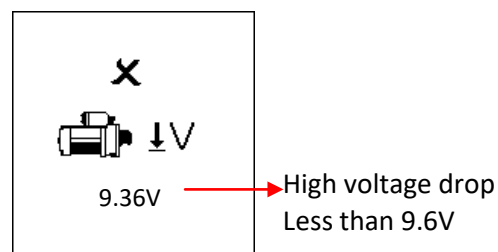





Fig. 45

Note:

9.6 Volt is the voltage drop limit for 12V system whereas 19.2Volt is for 24V system. Voltage drop more than the limits mentioned are considered bad.

- To print out the results, just press  key on the Analyser, the printer will start printing.
- Pressing the  key will exit and return back to the main menu screen (Fig.42)

Alternator Test:

This test is only available in  Test. It checks the MAX and MIN charging voltages output of Normal or Smart alternator at 2,500 ~3000 RPM without load and 1,500 ~ 2,000 RPM with all loads ON. As Normal and Smart Alternators on a 12V and 24V systems have its own set of parameters, it can determine the alternator's charging conditions and with the test results you can check its condition when in reference with the vehicle's Service Manual.

No load testing at 2,500 ~ 3,000 RPM

- With engine OFF, place the vehicle transmission in NEUTRAL for Manual and PARK for Automatic and apply the parking brake.
- Attach the Analyser clips onto the battery terminal posts and it will power up and lights up the LCD display screens as shown below:

Note:

The Analyser will auto detect the battery voltage once it had clamped onto the battery terminals, if it has detected a 24V battery then it will set its test perimeters to cater for 24V system and vice versa if it is a 12V system.

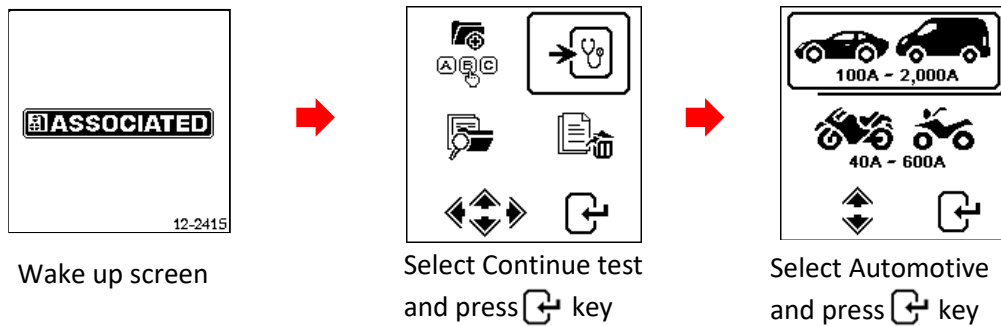

- From the main MENU (Fig.46), select  by scrolling left using  key.

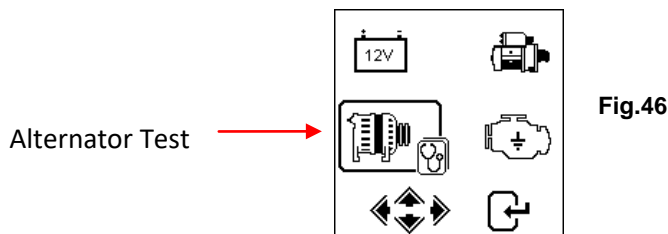

Press  key and the display will prompt you to select which type of Alternator (Smart or Normal) for testing (Fig. 47 below).

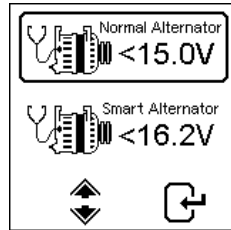

Once selected, press  key to continue and the display will show: (Fig.48). Start the engine if it is not running and keeps it r **Fig.47** idling speed. Make sure the Air condition is OFF.

Fig.48



4. Then rev the engine to around 2,500 ~ 3,000 RPM and hold at this speed. Press  key to continue and display will show. (See Fig. 49).

Fig.49

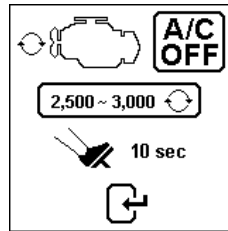

Rev engine around 2,500 to 3,000 rpm and hold at this speed.

Timer starts countdown from 10s to 0s

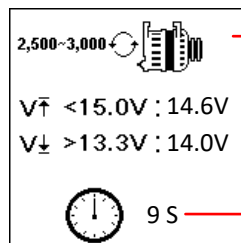
5. While still holding around 2,500 ~ 3,000 RPM, the timer will start to countdown from 10s to 0s. As soon as it reaches 0s, the results will automatically display as example shown below (Fig.50).





Average Charging Voltage 
 Max. Volts must less than 15.0V 
 Min. Volts must more than 13.3V 

Fig.50

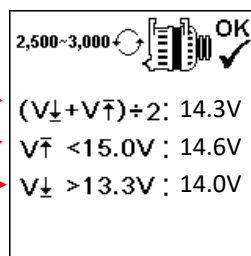

Captured readings:  Maximum Volts.
 Minimum Volts. 

With the captured readings, analysis can be done by referring to the limits as indicated:

Normal Alternator Charging:

12V System: No load - MAX voltage should **not exceed 15.0V** and MIN voltage should be **more than 13.3V**.

Loaded - Should be **more than 12.6V**

24V System: No load - MAX voltage should **not exceed 30.0V** and MIN voltage should be **more than 26.6V**.

Loaded - Should be **more than 25.2V**

Smart Alternator Charging:

12V System: No load - MAX voltage should **not exceed 16.2V** and MIN voltage should be **more than 12.4V**.

Loaded - Should be **more than 12.0V**

24V System: No load - MAX voltage should **not exceed 33.0V** and MIN voltage should be **more than 24.8V**.

Loaded - Should be **more than 24V**

- 6. If either minimum or maximum charging volts are not within the voltage range limits then it will display one of the screens as below (Fig.51 & 52) and it will highlighted which prompt you to check the charging system for the fault.

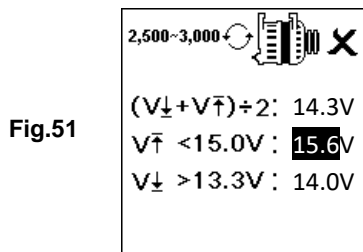

OR

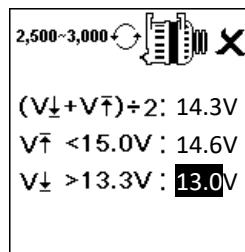

Testing with electrical load at 1,500 ~ 2,000 RPM

As more electrical accessories, such as lights, rear demister, heater, car stereos, etc. were used; voltage decreases and this will allow more amperage from the alternator to flow into the battery to compensate for the added load. This test is to check the alternator’s behavior during loading.

Continue from the previous test (either Fig. 50, 51 or 52); the Analyser will automatically proceed to Load test at 1,500 to 2,000 rpm. The display will show as below (Fig.53).

Switch ON all electrical loads
(Head lights – High & Low,
Radio, Heater, etc.)

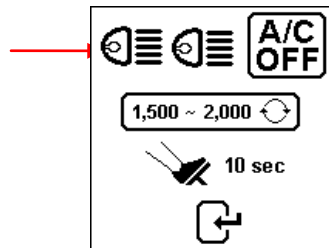

Switch ON all electrical loads (Head Lights, Radio, Rear Demister, Heater, etc.).

Note: Air-Condition (mostly mechanical load) should be OFF as it sometimes slowdown the idling speed of certain cars while it is ON thereby affecting the idling speed charging results.

- 7. Press key and the display will change to as shown in Fig. 54 below. Rev the engine up around 1,500 to 2,000 RPM by referring to the dashboard meter maintains the engine speed as shown in the example: (Fig. 54) below.

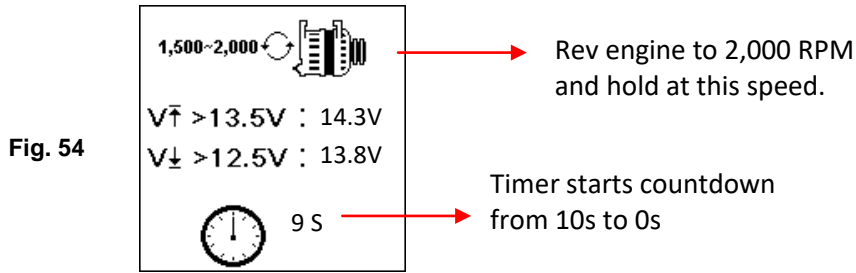

Wait for the countdown from 10s to 0s. As soon as it reaches 0s, the results will automatically display as example shown below (Fig.55).

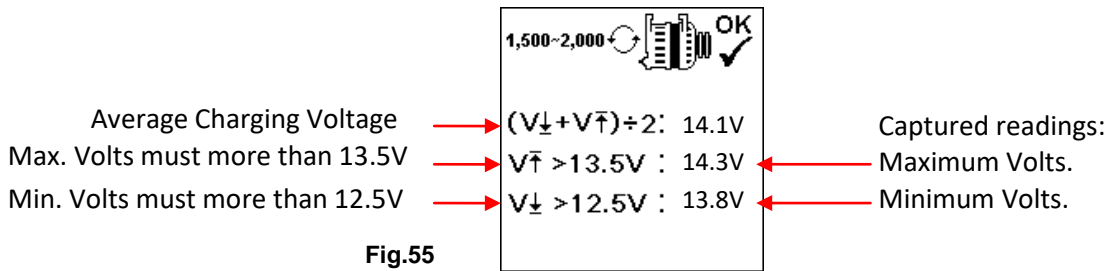

- 9. If either minimum or maximum charging volts are not within the voltage range limits then it will display one of the screens as below (Fig.56 & 57) and it will highlighted which prompt you to check the charging system for the fault.

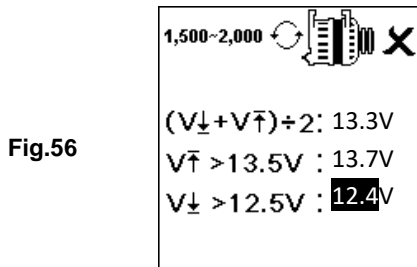

OR

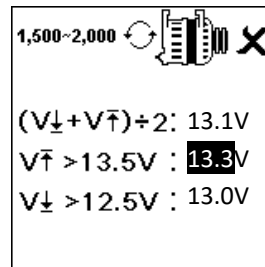

Testing diode ripple at idling speed with electrical load ON

This test is to check the AC ripple of the alternator diodes whether it is within the 0.5V limit. Normally if one of the diodes is faulty, the AC ripple will produce higher than the accepted 0.5V.

- 8. Continue from the previous test (either Fig. 55, 56 or 57); the Analyser will automatically proceed to diode ripple test. The display will show as below (Fig.58).

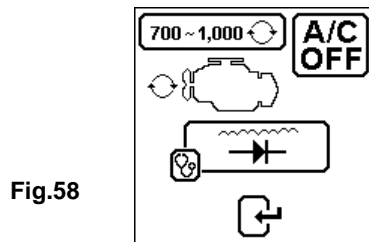

- 9. While the engine is still running, make sure the Air condition is OFF and the headlights (low and high beams) are switched ON. Press  key to continue and the display will change to (Fig.59) as shown below:

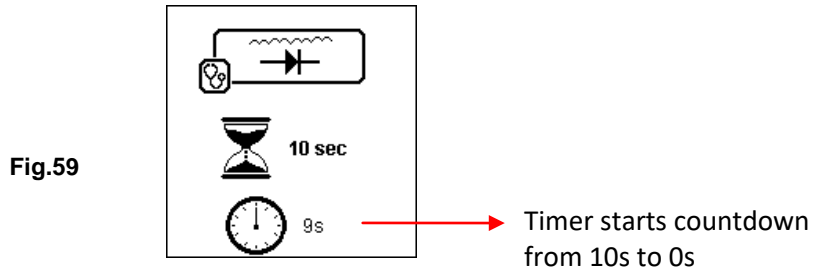

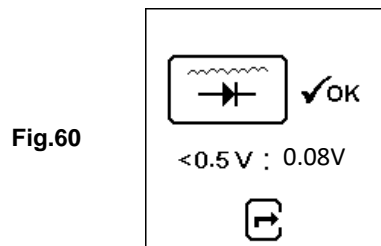

- 10. Wait for the countdown from 10 to 0. As soon as it reaches 0, the results will automatically display as example shown below (Fig.60).

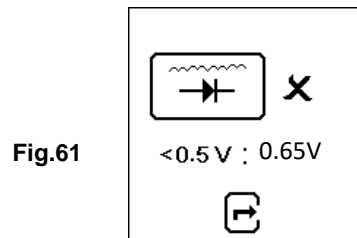

- 11. If the ripple voltage is above 0.5V then it will display (Fig.61) as below:



- 12. To printout the results, just press  key on the Analyser, the printer will start printing.

- 13. Pressing the  key will exit and return back to the main menu screen (Fig.46)

Grounding Test:

This test is only available in  only. The purpose of this test is to check the grounding cable condition to the engine body. As we know that if the grounding circuit is not good it may pose a lot of problems to the vehicle ECU. The Analyser will measure the contact resistance from the engine body to the battery terminal then it will display the results and the recommendations after each Test.

Again, this test can only perform with a 12V Battery. If you need to check grounding on a 24V vehicle system (12V x 2 batteries), all you have to do is to clamp onto one of the two batteries that provides the 12V for the operation.

If you had accidentally clamped onto a 24V battery output, it will remind you with the display as shown below (Fig. 62 and Fig. 63).

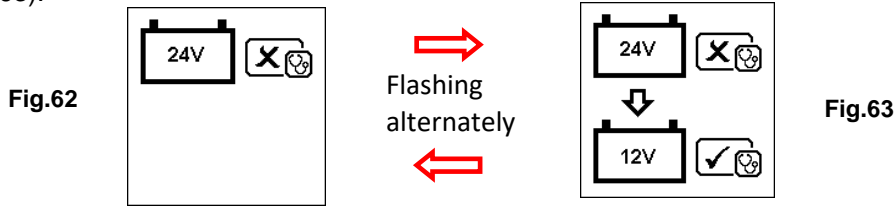

In this case, clamp the tester onto one of the 12V Battery that has a negative terminal connected the chassis (see Fig. 64 below).

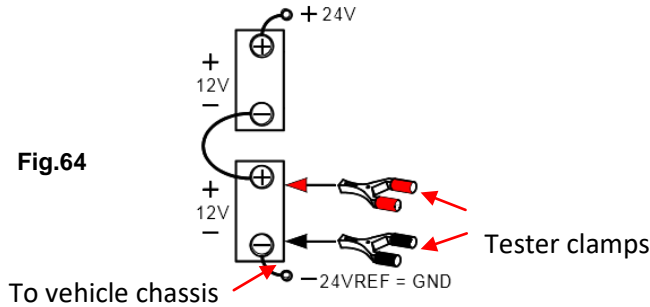

Note:

To conduct Ground Resistance test on a 24V (12V x 2 Batteries) System, always look for the 12V Battery with its negative terminal connected to the vehicle chassis (see Fig. 63 above). Clamp the tester clips onto this battery terminals will be able to proceed with the Test.

Start Testing

1. Make sure that the engine is switched OFF. Attach the clips onto the battery terminal posts and the analyser will power up and lights up the LCD display screen as shown below.

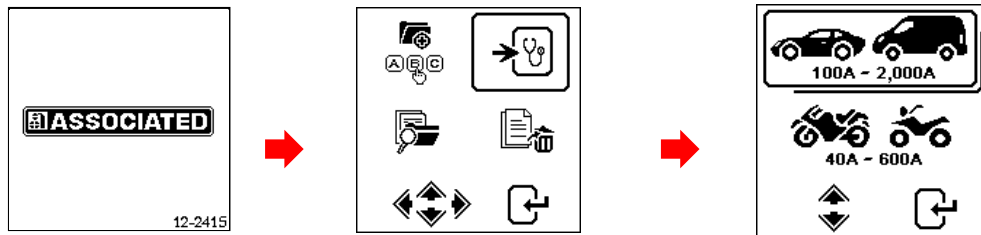

Wake up screen

Select Continue test and press key

Select Automotive and press key

2. From the main MENU, select by scrolling left using key. The screen will show (Fig.65).

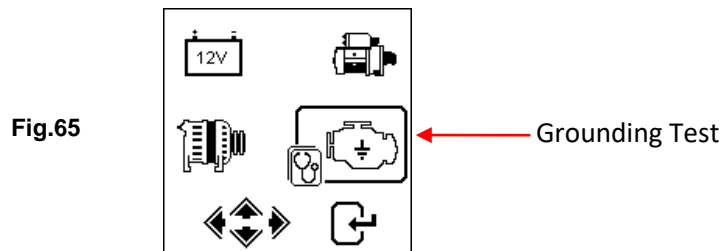

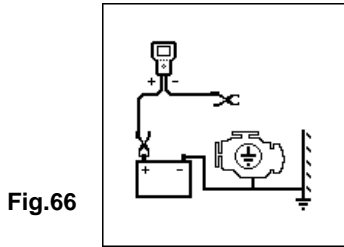

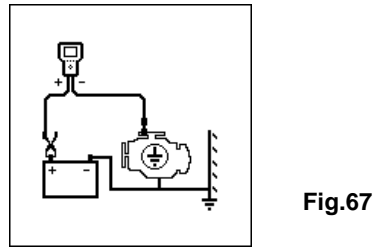

Fig.65

Press  key to continue and the display will show: (Fig.66 & 67)





Flashing alternately

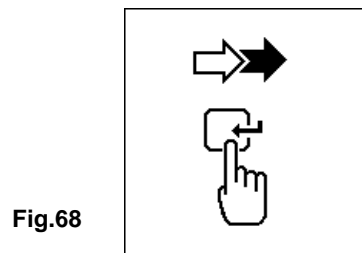

Now transfer the BLACK tester clip from the battery [-] terminal to a suitable position on the engine or chassis body leaving the RED clip still attached to the battery [+] terminal as shown above.

- As soon as the BLACK tester clip is attached to the engine body, the display will show: (Fig.68) which means that you need to press  key to continue.



- When  key is pressed, it will start analysing and the display will changed to the screen (Fig.69) below:

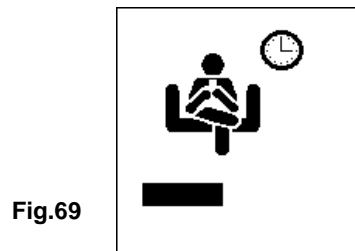

- Once it has finished analysing, it will prompt you with instructions (Fig. 70 & 71) stating that you have should unclamp the Black tester clip from the engine or chassis body and transfer to the battery negative [-] terminal within 15 seconds time limit if not the testing procedure has to be repeated again as the gathered data will be lost.

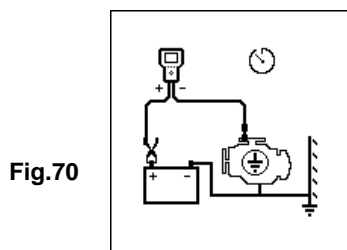

Flashing alternately

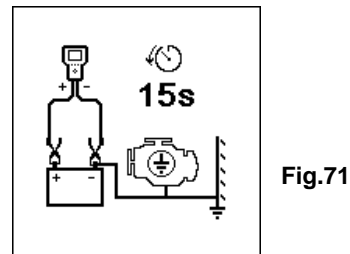
- Once the Black clip is clamped onto the battery [-] terminal, the Analyser display will light up as shown. (Fig. 72)

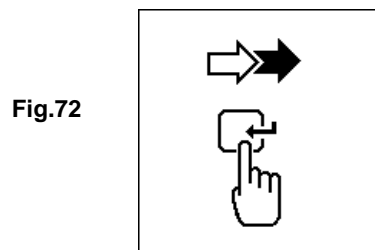

11. Now you need to press  key to proceed and the display will show as follows (Figure 73).

Fig.73



12. If the measured resistance reading is within limits, then it will display as follows (Fig.74)

Fig.74

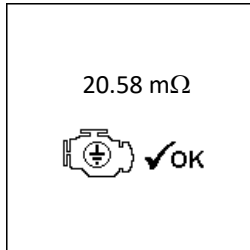

13. If the measured resistance reading has gone beyond the limits, then it will display the screen as follows (Fig. 75).

Fig.75

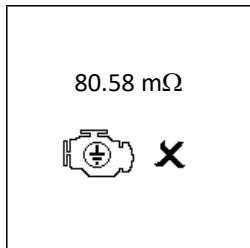

Note:

The above indicates that the ground contact from the engine body to the battery is bad. Check for rusted or corroded point of contacts. If found, dismantle it for cleaning or replace before fixing back. Repeat the test again after fixing.

14. If you did not follow the right procedures during the testing, it will display the results as follows (Fig. 76) below:

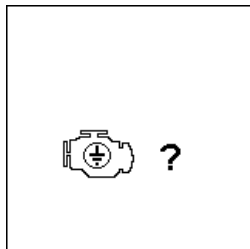



Fig.76

15. To printout the results, just press  key on the Analyser, the printer will start printing.

16. To exit the program, pressing the  key at any moment will exit and return back to the main menu screen (Fig.65).

View Test Results from memory:

To view the all the test results, the Analyser have to be connected to an external power source by either clamping its clips directly to a 12Volt car battery or connected to a PC via the USB port using an USB cable.



1. Once power up, the wakeup screen will display as follows: (Fig.77 & 78)

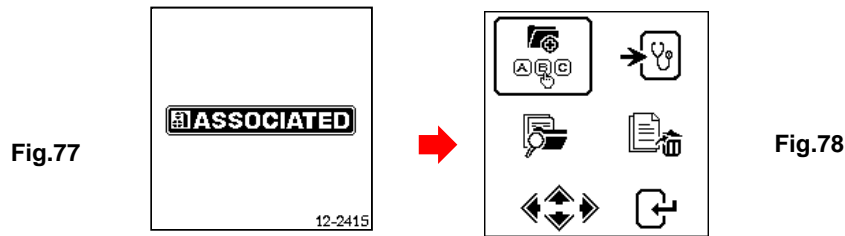

2. Select **View Test Report from memory** by scrolling with ▼ key to . See display below (Fig.79):

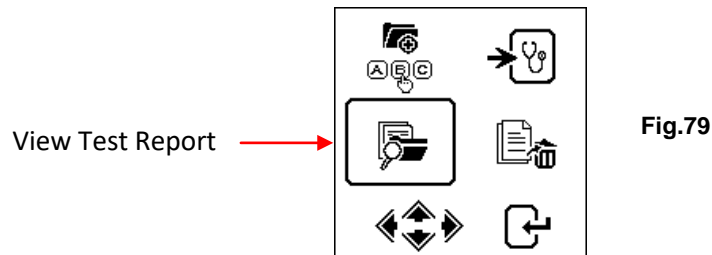

3. Once  key is pressed, the display will show as follows (Fig. 80):



Select the particulars that you had keyed in earlier from the list by scrolling the highlighted bar up or down when pressing ▲ or ▼ key. If the particular is not in the list that you are looking at, you may go to the next page by pressing ◀ or ▶ key. Once you had found it then press  key to confirm. The display will show the results stored from its memory as example shown below:

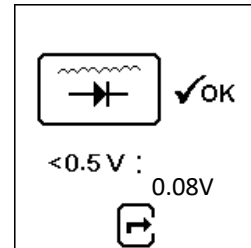
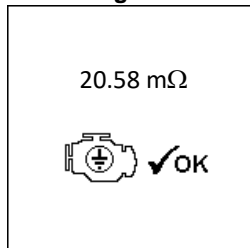
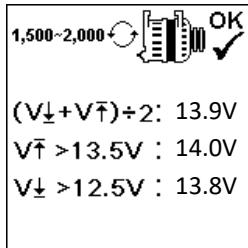
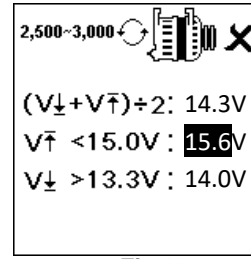
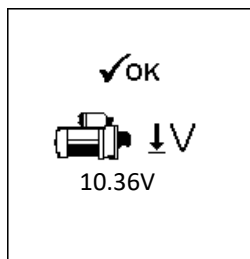
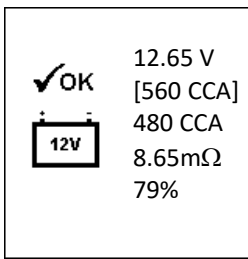

Fig.84

Fig.82

Fig.83

Fig.85

Fig.86

Printout of stored Test Results:

Important:

The Analyser has to be connected to a 12V battery in order to work with its printer. This is because the printer needs higher Amps to operate which the PC USB output is unable to provide.

Printing of the stored Test Results can be done while in this View Test results from stored memory (Fig. 81 ~ 86). To print just press key on the Analyser, the printer will start printing.

An example of the printout as shown in Fig.87 below:

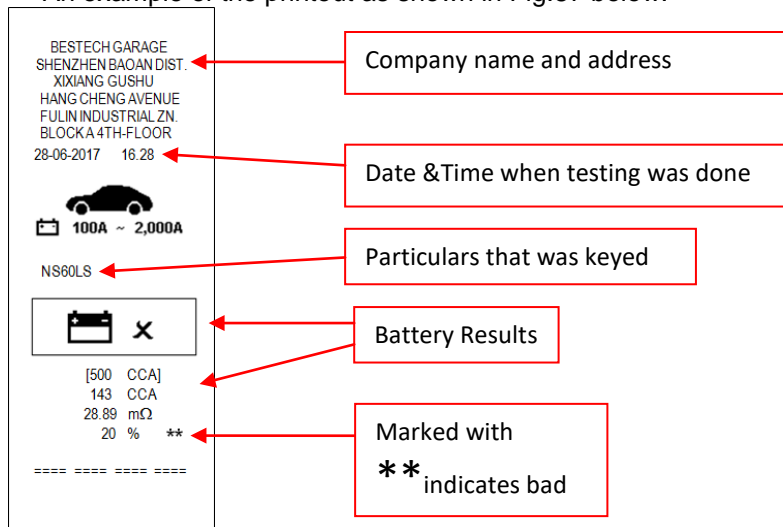

Fig.87

Note: To printout on normal computer printer, it has to be connected to the PC with the Analyser software installed. (See Print Results from PC Printer – Page 34).

To exit the program, pressing the key at any moment will exit and return back to the main menu screen (Fig.79).

Personal Computer (PC) Link:

The Analyser is also designed to link with PC for data storage and printout through normal printer. To do so, the PC has to install the driver first and the software provided in order to operate.

Installing Driver



Important to Note:

Before you start to install the driver, please do not plug the Analyser into the computer's USB port or else the installation will fail and the computer cannot detect the proper driver for the Analyser when connected.

If you have made the above error and wish to install the driver the second time, you need to uninstall the previously installed driver first before starting to reinstall again. This time make sure that the Analyser is not plugged in.

Step 1. You can install the driver as provided.

First click to open the folder:  BESA-12G Software & Driver

You will find the following files:  BESA-12G Setup.exe  BESA-12G XP_Vista_7_8 Driver Installer.exe

Step 2. Double click on the icon . The installation will start automatically. Typical example below is for Windows 7 operating system.

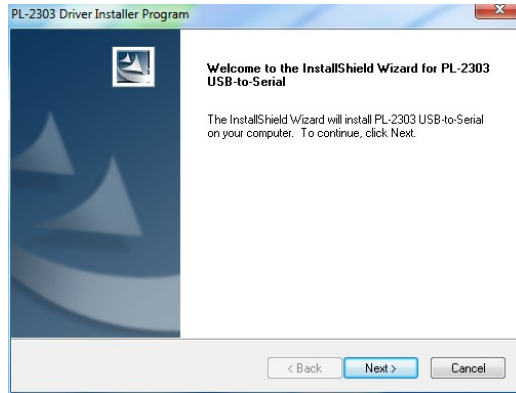

As instructed, click [Next>] tab the program will continue to install the driver on the computer. Once it had finished, it will prompt you as shown below. Click [Finish] tab to complete the installation.

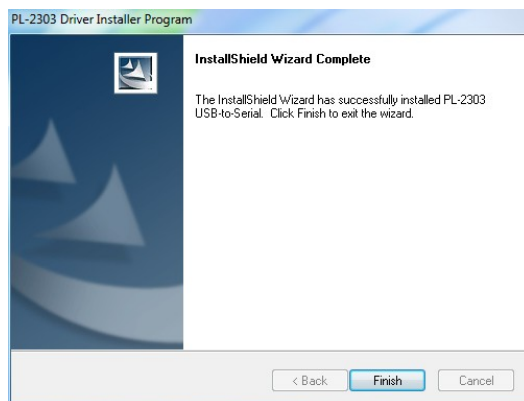

Step 3. Next open this folder again:

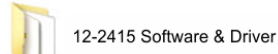

Look for the program icon:



Then double click to open the program. See examples below:



Click "Next" tab to continue the installation and the software will start to install.

A few seconds later, the display will show as below that the installation has been completed and click "OK" tab to exit.



Once the software has been installed, the icon  will appear on the desktop.

Step 4. Now plug the Analyzer into any one of the PC USB port and try to link up the Analyser with the PC by the following procedures:

1. Go to the main Menu (Fig.88), select View Test Results (Fig.89) as shown below:

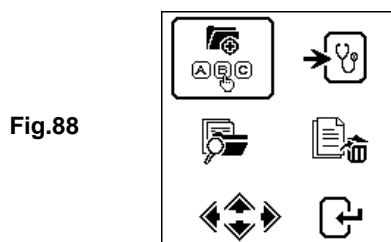

Fig.88

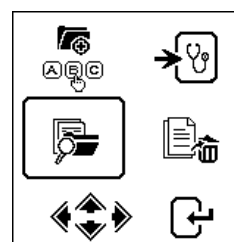
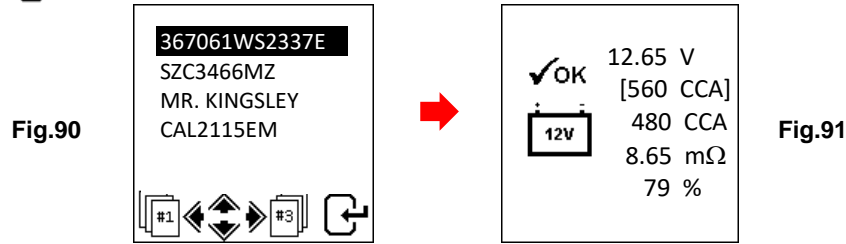

Fig.89

While in display Fig.90, select which results you need to view by scrolling ▼ or ▲ key and then press ↻ key will get into the test result display as example shown (Fig.91).



2. Press USB key on the keypad will display (Fig.92) as shown below:

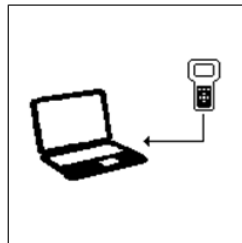

Fig.92

It will remain in this display while logging into the PC. Do not press any other keys because the Analyser is already communicating with the PC.

Step 5. On the PC, go to desktop display and look for  icon. Left click on the icon to open the program and the display page will show as below:

COM Port

Customer name

Battery Brand or Model

Click Header & Footer here to put your Company name and address.

It will automatically detect COM Port.

Add the above particulars to test report.

Transfer data from Analyser

Print

Save

1. To confirm whether there is communication; click on  [Transfer Data from Analyser] tab and the Test Result will appear. See example below.

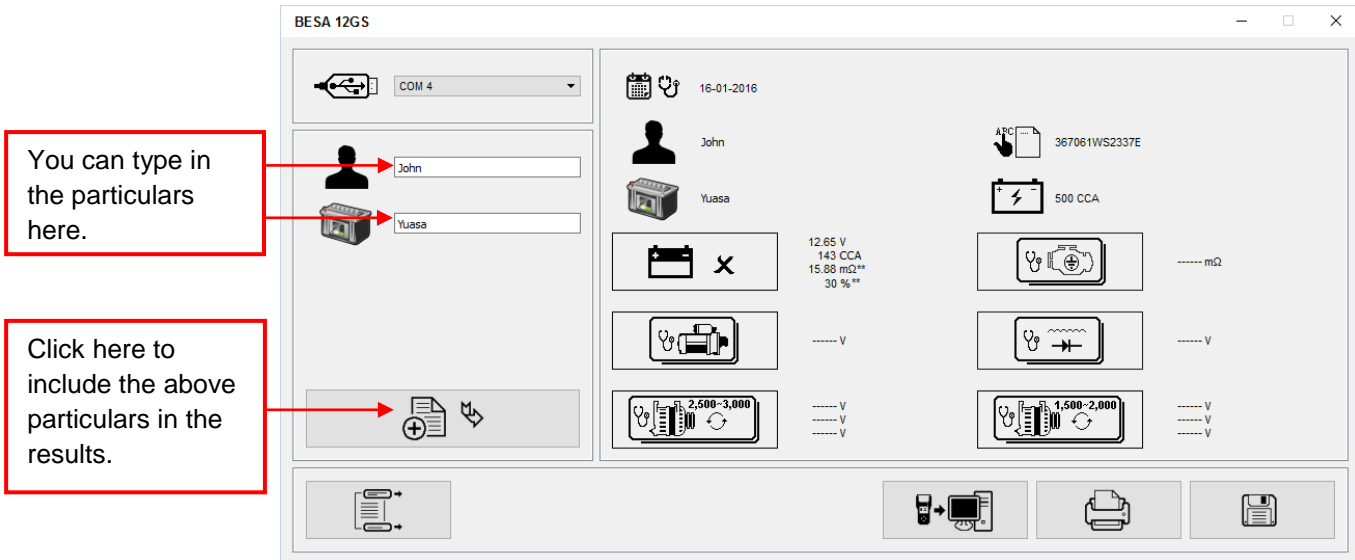

The screenshot shows the BESA 12GS software window. On the left, there are input fields for 'John' and 'Yuasa'. A red box points to these fields with the text 'You can type in the particulars here.' Below them, a button with a plus sign and a document icon is highlighted with a red box and the text 'Click here to include the above particulars in the results.' The main area displays test results for a battery, including voltage (12.85 V), CCA (143 CCA), and other metrics. At the bottom, there are icons for 'Transfer Data from Analyser', 'Print', and 'Save'.

2. If there is no communication, a message text box will appear (see below) Fig. 93



Fig.93

In this case, unplug the Analyzer from the PC and repeat Step 4 and Step 5. If problem persists, then select an alternate COM PORT individually from the dropdown list and

click  tab to see whether the Last Test Result will appear (as displayed in Step 5).

If the above fails again, then try plugging the Analyzer to the PC's another USB port and repeating Step 4 and 5 again.

Printing Results from PC Printer:

While on this page, if you wish to print out the results, make sure that your printer is connected to the computer.

Click on  tab and a text box will appear. Select the right printer and click [Print] tab to print.

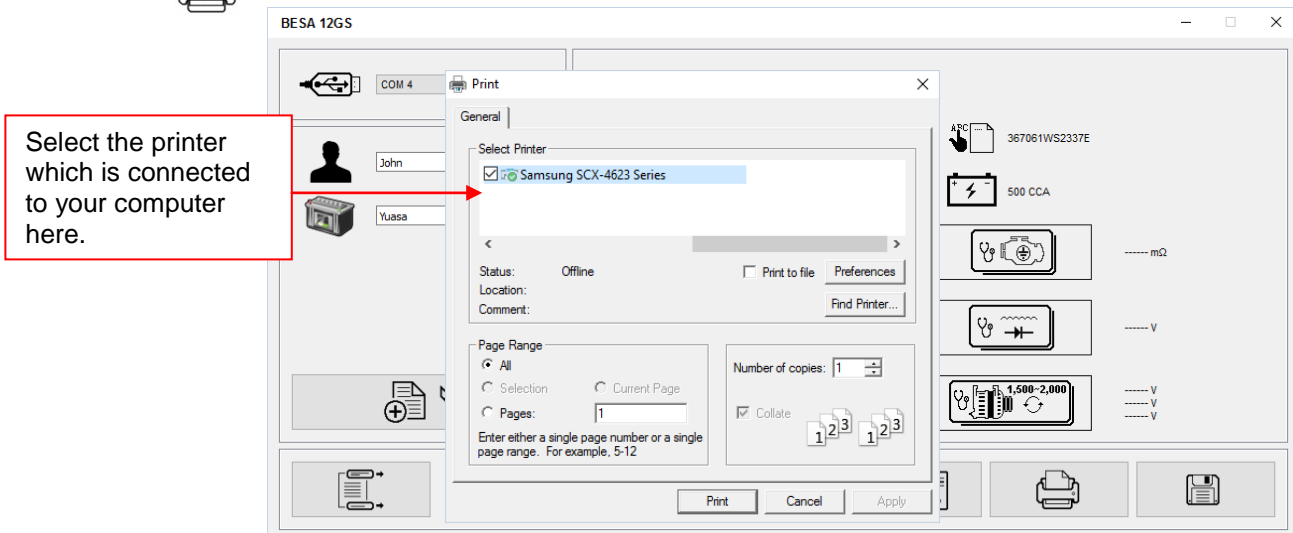

The screenshot shows the BESA 12GS software window with a 'Print' dialog box open. The dialog box has a 'Select Printer' section where 'Samsung SCX-4623 Series' is selected. A red box points to this selection with the text 'Select the printer which is connected to your computer here.' The dialog box also shows printer status (Offline), page range options, and a 'Number of copies' field set to 1. The background software window shows the same test results as in the previous figure.

Saving Results:

Note:

The results will be saved in MS Office Word Document format. You need to set the paper size to A4 beforehand if not the printout and the stored results page will not be in A4 size. Otherwise with other paper size settings, they may affect the layout of the results when printed out because of the graphics involved.

To do so while in MS Office Word page, go to [Page Layout] tab and right click, display shows as in Fig. A.

Left click here

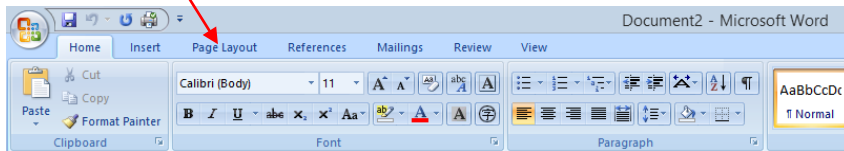
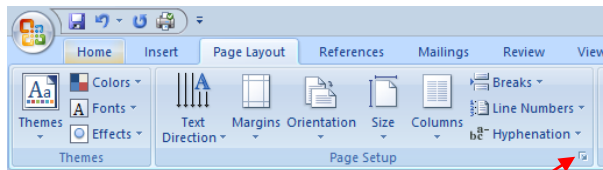



Fig. A



Left click here

On [Page Layout], left click on  sign (see Fig. A) to show Page Setup dialogue box as shown (Fig. B) below. Then select [Paper] tab and browse [paper size] drop down menu for A4 click on it (Fig. C). Click [OK] to apply and confirm.

Left click here



Fig. B



Fig. C

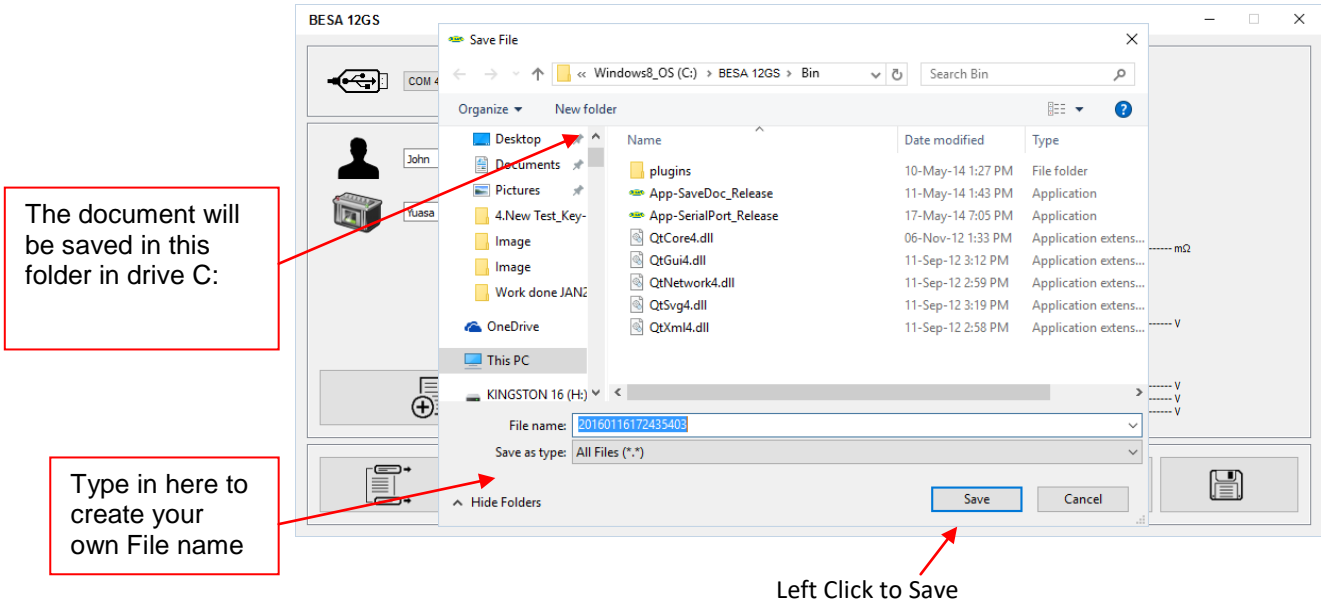

Left click here

To the save results, click on  tab. A message box (see below) will appear. Create a file name and then click [Save] tab as shown below.



Erase off all the stored Results in the memory:

This function allows you to erase off all the results stored in its memory and start a fresh new list

after you had backup all the stored results to the PC. To access into this function, select  and press  key, the display will show (Fig.95) as shown below:

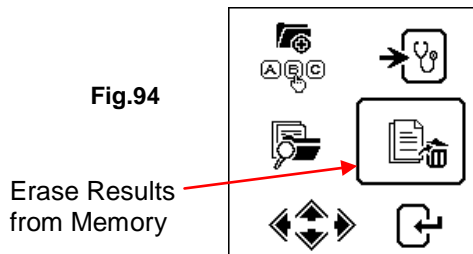

1. Press and hold ◀ and ▶ keys together, a few seconds later the display will change to (Fig. 96) as shown below and that completes the process.

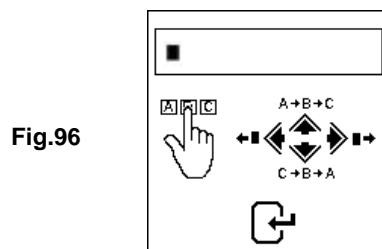

Warning: Performing the above procedures will erase off all the records from the tester.

Disclaimer

All information, illustrations, and specifications contained in this user manual are based on the latest information available at the time of printing. The right is reserved to make any changes at any time without obligation to notify any person or organization of such revisions or changes.

Furthermore, the manufacturer or its sales agents are not liable for errors contained herein or for incidental or consequential damages (including lost profits) in connection with the furnishing, performance or use of this material.

This user manual tells how to use and perform the required procedures during testing. Safe and effective use of this tester is very much dependent on the user following the normal practices and procedures outline in this manual.

Warranty Information:

Limited Warranty

This limited warranty cover defects in materials and workmanship for a period of twelve (12) months which begins from the date the product is purchased by the end user and is subjected to the following terms and conditions:

1. Within the warranty period, the manufacturer will repair or replace, at their options, any defective parts and return to the owner in good working condition.
2. Any repaired or replaced parts will be warranted for the balance of the original warranty or three months (3) months from the date of repair, whichever is longer.
3. This warranty only extends to the first owner and not assignable or transferable to any subsequent owner.
4. Cost of delivery charges incurred for the repair of the product to and from the manufacturer will be borne by the owner.
5. This limited warranty covers only those defects that arises as a result of normal use and does not cover those that arises as a result of:
 - Unauthorized modifications and repair.
 - Improper operation or misuse.
 - Accident or neglect such as dropping the unit onto hard surfaces.
 - Contact with water, rain or extreme humidity.
 - Contact with extreme heat.
 - Cables that have broken, bent contact pins or subject to extreme stress or wear.
 - Physical damage to the product surface including scratches, cracks or other damage to the display screen or other externally exposed parts.

Limitations of Warranty

Other than the foregoing limited warranty, the manufacturer does not make any other warranty or condition of any kind, whether express or implied.

Any implied warranty of merchantability, or fitness for use shall be limited to the duration of the foregoing limited warranty.

Otherwise, the foregoing limited warranty is the owner's sole and exclusive remedy and is in lieu of all other warranties whether express or implied.

The manufacturer or any of its exclusive sales agents shall not be liable for any consequential or incidental damages or losses arising of the loss of uses of this product.

All warranty information, product features and specifications are subjected to change without prior notice.